

# Precious®—OVAL CHANGING STATION

## Installation Instructions (*IMPORTANT: Keep for future reference – Read Carefully*)

### What you will need:

- Measuring Tape
- Stud Finder
- Screwdriver
- 7/32" Drill Bit (regular & masonry)
- 1/8" Drill Bit (regular & masonry)
- 1/2" Drill Bit (regular & masonry)
- Drill
- Pencil



1 Depot

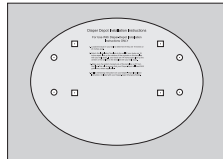

1 Mounting Template



4 Washers



4 Screws



4 Washers



4 Bolts



4 Toggles



1 Decal

Determine which mounting hardware will be used:

**Set A** – Wood Screws for mounting into wood studs

**Set B** – Toggle Bolts for mounting into metal studs or sheetrock/tile wall (a clearance of 3-1/2" is required behind the wall for the toggle to expand).

**Locate studs to determine which set of recessed mounting holes will be used – 16" or 24" centers.**

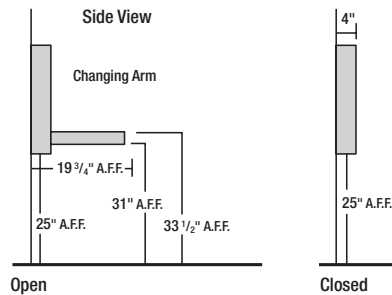

Manufacturer strongly recommends installation as shown. When installed at 25" A.F.F., as depicted, along an accessible route, the Diaper-Depot meets the following requirements of the ADA accessibility guidelines, when applicable:

- 4.4.1 Protruding objects (closed unit)
- 4.2.5 Forward reach
- 4.2.6 Side reach
- 4.23.3 and 4.23.7 fixtures
- 4.32.3 Knee clearances at counter
- 4.32.4 Height of counters

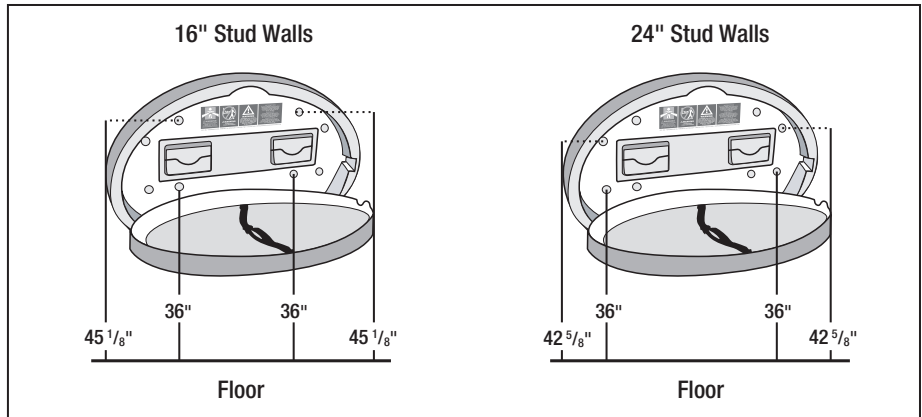

- Using the mounting template or diagrams above as a guide, mark the four mounting points on the wall. If you are using 16" stud walls, mark the top two holes 45-1/8" above the floor and the lower two holes 36" above the floor. If you are using 24" stud walls, mark the top two holes 42-5/8" above the floor and the lower two holes 36" above the floor. Measure the exact distance between the holes you are using, from the back of the depot, and transfer these measurements onto the corresponding wall lines.

- For Wood Studs:** Drill through the ceramic tile or surface finish at the marked hole locations with a 7/32" masonry bit until you hit the stud, then change to a 1/8" regular bit to complete the hole through the stud.

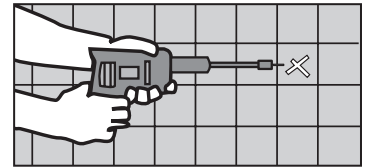

- For Metal Studs Or Underlying Surface of Concrete Block:** Drill at the marked hole locations with a 1/2" masonry drill bit. You must allow a minimum 3-1/2" of inside wall space for toggles to turn. Insert and tighten all four toggles.

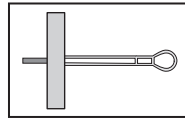

A. Insert toggle in hole drilled

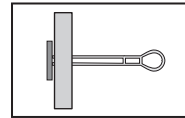

B. Pull ring and push cap lightly against wall

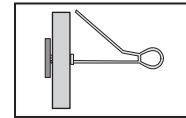

C. Snap off strap

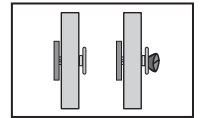

D. Install unit using screws and washer supplied

- Place a finishing washer first and then a fender washer over each screw.

- For Wood Studs** — Lift the depot in the open position and align the wood screws into the lower pre-drilled holes. Tighten each screw until the unit is held firmly in place. Repeat installation of the lower screws and tighten all screws until the unit is held securely.



- For Metal Studs Or Underlying Surface Of Concrete Block** — Lift the depot in the open position and align mounting holes with pre-drilled holes. Insert machine screws with washers into pre-drilled holes. Tighten each bolt until the unit is held securely in place.

**Remove backing from decal and secure it to the outside of the restroom door or other highly visible location.**



# WARNING

**Never leave child unattended**

**Designed for infants only. Age up to 3.5 years  
and weighing less than 50 lbs.**

**Keep one hand on the child at all times**

**Avoid serious injury from falling or sliding out**

**Always use restraint system**

## **Adequate Use of Restraint System**

- **Lay child on their back in the bed portion of the diaper changer**
- **Place the restraint belt around the child**
- **Insert the two ends of the buckle into each other until you hear a click**
- **Give a slight tug to make sure the buckle is locked**
- **Use the adjustment glider to tighten the restraint securely around the child**

- Please be advised that parcels or accessory items, or both, placed on the unit may cause the unit to become unstable.
- The maximum recommended weight for this unit is 50 pounds. Excessive weight placed on the unit may cause a hazardous unstable condition to exist.
- All assembly parts must be sufficiently tightened at all times. Screws cannot be loose, as the child's body parts or clothing (such as straps, necklaces, ribbons, dolls, etc.) may get pinched. This may cause a suffocation hazard.
- Be aware of the risk of open fire and other strong heat sources, such as electric heaters, gas stoves, etc. in the immediate surroundings of the diaper changing station
- Wipe down regularly with mild cleansers